





| | | | | | |
|-----------------------|--------|------------------|----------|--------------|--------|
| Messrs. | | | | | |
| Product Specification | Model: | MTF-TQ28NP911-LB | Rev. No. | Issued Date. | Page. |
| | | | A | Feb.27,09 | 1 / 26 |

LIQUID CRYSTAL DISPLAY MODULE
MODEL: MTF-TQ28NP911-LB
Customer's No.:

| |
|------------|
| Acceptance |
| |

Microtips Technology Inc.
12F. No.31 Lane 169, Kang Ning St.,
His-Chih, Taipei Hsien, Taiwan
FAX: 886-2-26958625

| |
|-------------------------|
| Approved and Checked by |
| |

| Approved by | Checked by | | Made by |
|---|---|--|---|
|  |  |  |  |



Microtips Technology Inc.

| | | | | | |
|-----------------------|--------|------------------|----------|--------------|--------|
| Messrs. | | | | | |
| Product Specification | Model: | MTF-TQ28NP911-LB | Rev. No. | Issued Date. | Page. |
| | | | A | Feb.27,09 | 3 / 26 |

Contents

| | |
|---|----|
| 1. GENERAL DESCRIPTION | 4 |
| 2. FEATURES | 5 |
| 3. MECHANICAL SPECIFICATION | 4 |
| 4. ELECTRICAL CHARACTERISTICS | 5 |
| 4.1 Backlight Characteristic | 6 |
| 4.2 Touch Panel Pin Assignment | 6 |
| 4.3 Pin Description | 6 |
| 4.4 System Interface | 6 |
| 4.5 GRAM Address Map & Read / Write | 6 |
| 5. ELECTRO-OPTICAL CHARACTERISTICS | 7 |
| 5.1 Reliability of Touch Panel | 7 |
| 6. RELIABILITY | 16 |
| 6.1 MTTF | 17 |
| 6.2 Tests | 17 |
| 7. INSPECTION CRITERIA | 17 |
| 7.1 Inspection Conditions | 16 |
| 7.2 Light Method | 18 |
| 7.3 Classification of Defects | 18 |
| 7.4 Sampling & Acceptable Quality Level | 18 |
| 7.5 Definition Of Inspection Area | 18 |
| 7.6 Items and Criteria | 18 |
| 8. PRECAUTIONS | 22 |
| 8.1 Operation | 22 |
| 8.2 Safety | 22 |
| 8.3 Handling | 22 |
| 8.4 Static electricity | 24 |
| 8.5 Storage | 24 |
| 8.6 Cleaning | 24 |
| 8.7 Waste | 24 |
| 9. WARRANTY | 25 |
| 10. DIMENSIONAL OUTLINES | 25 |



| | | | | | |
|-----------------------|--------|------------------|----------|--------------|--------|
| Messrs. | | | | | |
| Product Specification | Model: | MTF-TQ28NP911-LB | Rev. No. | Issued Date. | Page. |
| | | | A | Feb.27,09 | 4 / 26 |

1. GENERAL DESCRIPTION

The MTF-TQ28NP911-LB model is a Color TFT LCD supplied by Microtips. This main Module has a 2.8 inch Diagonally measured active display area with 240 x RGB x 320 Resolution. Each pixel is divided into Red, Green and Blue sub-pixels and dots which are arranged in vertical stripes. LCD color is determined with Dithering 65K/262K Color signal for each pixel. The MTF-TQ28NP911-LB has been designed to apply the interface method that enables low power, high speed, and high contrast. The MTF-TQ28NP911-LB is intended to support Applications where thin thickness, wide viewing angle, low power are critical factors and graphic displays are important.

2. FEATURES

| | |
|-------------------|---|
| Display Mode | TFT module, Transmissive Type, Positive mode |
| Display Format | RGB vertical stripe |
| Color | 56K/262K color |
| Input Data | MCU Mode : 8080 system ; 8/9/16/18 bits interface |
| Viewing Direction | 12 O'clock |
| Backlight | White LED |

3. MECHANICAL SPECIFICATION

| Item | Specifications | Unit |
|---------------------|--|-------|
| Dimensional outline | 50 (W) × 69.2 (H) × 3.8 (D) without fix posts & FPC tails. | mm |
| Resolution | 240 x RGB x 320 | Pixel |
| Active area | 43.2 (W) × 57.6 (H) | mm |
| Pixel pitch | 0.18 (W) × 0.18 (H) | mm |
| Dots pitch | 0.06 (W) × 0.18 (H) | mm |

* Not: Include FPC

* 1 Pixel =3 dots = Red dot + Green dot + Blue dot



Microtips Technology Inc.

| | | | | | |
|-----------------------|--------|------------------|----------|--------------|--------|
| Messrs. | | | | | |
| Product Specification | Model: | MTF-TQ28NP911-LB | Rev. No. | Issued Date. | Page. |
| | | | A | Feb.27,09 | 5 / 26 |

4. ELECTRICAL CHARACTERISTICS

Typical operating conditions (GND=AV ss=0V)

| Item | Symbol | Min | Typ | Max | Units |
|-----------------------------|--------|-----|-----|-----|-------|
| Power Supply | VDD | -- | 2.8 | -- | V |
| | IDD | -- | 10 | 12 | mA |
| Consumption current of VLED | VLED | -- | -- | 3.5 | V |
| | ILED | -- | 80 | -- | mA |
| Operating Temperature | TOP | -20 | -- | 70 | °C |
| Storage Temperature | TSTG | -30 | -- | 80 | °C |
| Humidity | -- | -- | 90 | %RH | Note1 |

Note1: $T_A \leq 40^\circ\text{C}$ Without dewing

4.1 Backlight Characteristic

| Item | Symbol | Condition | Min | Typ | Max | Units |
|--|--------|------------------------|-----|-----|-----|-------|
| LED module voltage | VLED | ILED=20mA | -- | -- | 3.5 | V |
| LED module current | ILED | VLED=3.5V | -- | 80 | -- | mA |
| Surface brightness uniform (without LCD) | Ld | ILED=80mA VLED=3.5V | 75 | 80 | -- | % |

* 1 Backlight LED Circuit:

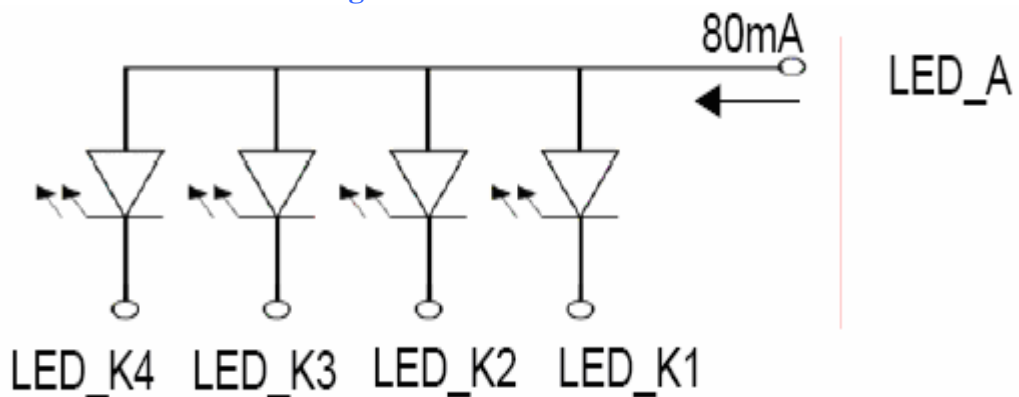

| | | | | | |
|-----------------------|--------|------------------|----------|--------------|--------|
| Messrs. | | | | | |
| Product Specification | Model: | MTF-TQ28NP911-LB | Rev. No. | Issued Date. | Page. |
| | | | A | Feb.27,09 | 6 / 26 |

*** 2 Uniform measure condition :**

- (a) Measure 9 point. Measure location is show below :
- (b) Uniform = (Min. brightness / Max. brightness) * 100%
- (c) Best Contrast, Main and sub panel All dots tum ON (White screen)

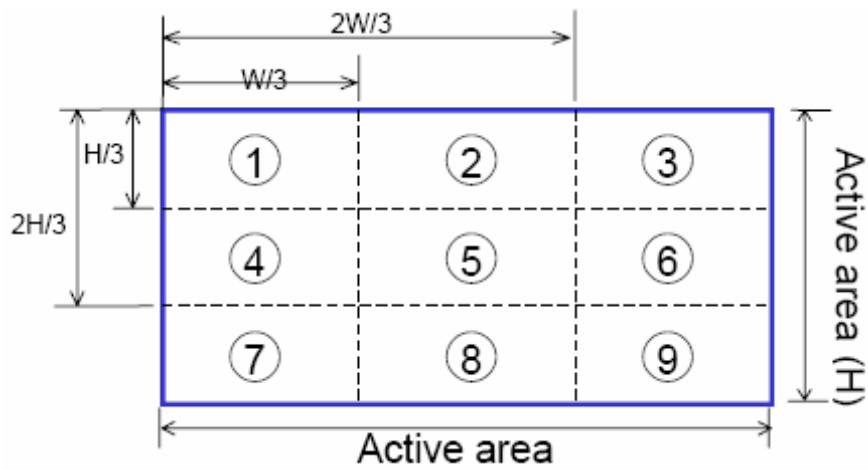

4.2 Touch Panel Pin Assignment

| Pin No. | Designation |
|---------|-------------|
| 1 | YU |
| 2 | XL |
| 3 | YD |
| 4 | XR |



| | | | | | |
|-----------------------|--------|------------------|----------|--------------|--------|
| Messrs. | | | | | |
| Product Specification | Model: | MTF-TQ28NP911-LB | Rev. No. | Issued Date. | Page. |
| | | | A | Feb.27,09 | 7 / 26 |

4.3 Pin Description

| No | Pin Name | Functions | | |
|---|----------|------------------------------|-----|-----------|
| 1 | VDD | Power input (+2.8V) | | |
| 2 | VDD | Power input (+2.8V) | | |
| 3 | GND | Power Ground | | |
| 4 | GND | Power Ground | | |
| 5 | CS | Chip Select Input PIN | | |
| 6 | RS | Register Select Input PIN | | |
| 7 | WR | Chip Select Input PIN | | |
| 8 | RD | Read Data Select Input PIN | | |
| 9~26 | DB0~DB17 | Data Bus Pin | | |
| 27 | RESET | Reset Select Input PIN | | |
| 28 | GND | Power Ground | | |
| 29~30 | IM0~IM3 | Mode Select | | |
| | | IM0 | IM3 | Interface |
| | | 0 | 1 | 8-bits |
| | | 1 | 1 | 9-bits |
| | | 0 | 0 | 16-bits |
| | | 1 | 0 | 18-bits |
| 31 | K4 | B/L Power input PIN negative | | |
| 32 | K3 | B/L Power input PIN negative | | |
| 33 | K2 | B/L Power input PIN negative | | |
| 34 | K1 | B/L Power input PIN negative | | |
| 35 | AN | B/L Power input PIN anode | | |
| 36 | NC/ YU | Not Connect | | |
| 37 | NC/ XL | Not Connect | | |
| 38 | NC/ YD | Not Connect | | |
| 39 | NC/ XR | Not Connect | | |
| <p>Note :</p> <p>80-system 8-bits used DB17 : DB10</p> <p>80-system 9-bits used DB17 : DB9</p> <p>80-system 16-bits used DB17 : DB10 and DB7 : DB0</p> <p>80-system 18-bits used DB17 : DB0</p> | | | | |



| | | | | | |
|-----------------------|--------|------------------|----------|--------------|--------|
| Messrs. | | | | | |
| Product Specification | Model: | MTF-TQ28NP911-LB | Rev. No. | Issued Date. | Page. |
| | | | A | Feb.27,09 | 8 / 26 |

4.4 System Interface

4.4.1 8080-System Interface Timing

| Item | | Symbol | Unit | Min | Typ | Max | Test Condition |
|-------------------------------|-------------------------------|------------------------------------|------|-----|-----|-----|----------------|
| Bus cycle time | Write | t _{CYCW} | ns | 100 | -- | -- | -- |
| | Read | t _{CYCR} | ns | 300 | -- | -- | -- |
| Write low-level pulse width | | PW _{LOW} | ns | 50 | -- | 500 | -- |
| Write high-level pulse width | | PW _{HW} | ns | 50 | -- | -- | -- |
| Read low-level pulse width | | PW _{LR} | ns | 150 | -- | -- | -- |
| Read high-level pulse width | | PW _{HR} | ns | 150 | -- | -- | -- |
| Write / Read rise / fall time | | t _{WRi} /t _{WRf} | ns | -- | -- | 25 | -- |
| Setup time | Write (RS to NCS ,E/NWR) | t _{AS} | ns | 10 | -- | -- | -- |
| | Read (RS to NCS ,RW/NRD) | | | 5 | -- | -- | |
| Address hold time | | t _{AH} | ns | 5 | -- | -- | -- |
| Write data set up time | | t _{DSW} | ns | 10 | -- | -- | -- |
| Write data hold time | | t _H | ns | 15 | -- | -- | -- |
| Read data delay time | | t _{DDR} | ns | -- | -- | 100 | -- |
| Read data hold time | | t _{DHR} | ns | 5 | -- | -- | -- |



| | | | | | |
|-----------------------|--------|------------------|----------|--------------|--------|
| Messrs. | | | | | |
| Product Specification | Model: | MTF-TQ28NP911-LB | Rev. No. | Issued Date. | Page. |
| | | | A | Feb.27,09 | 9 / 26 |

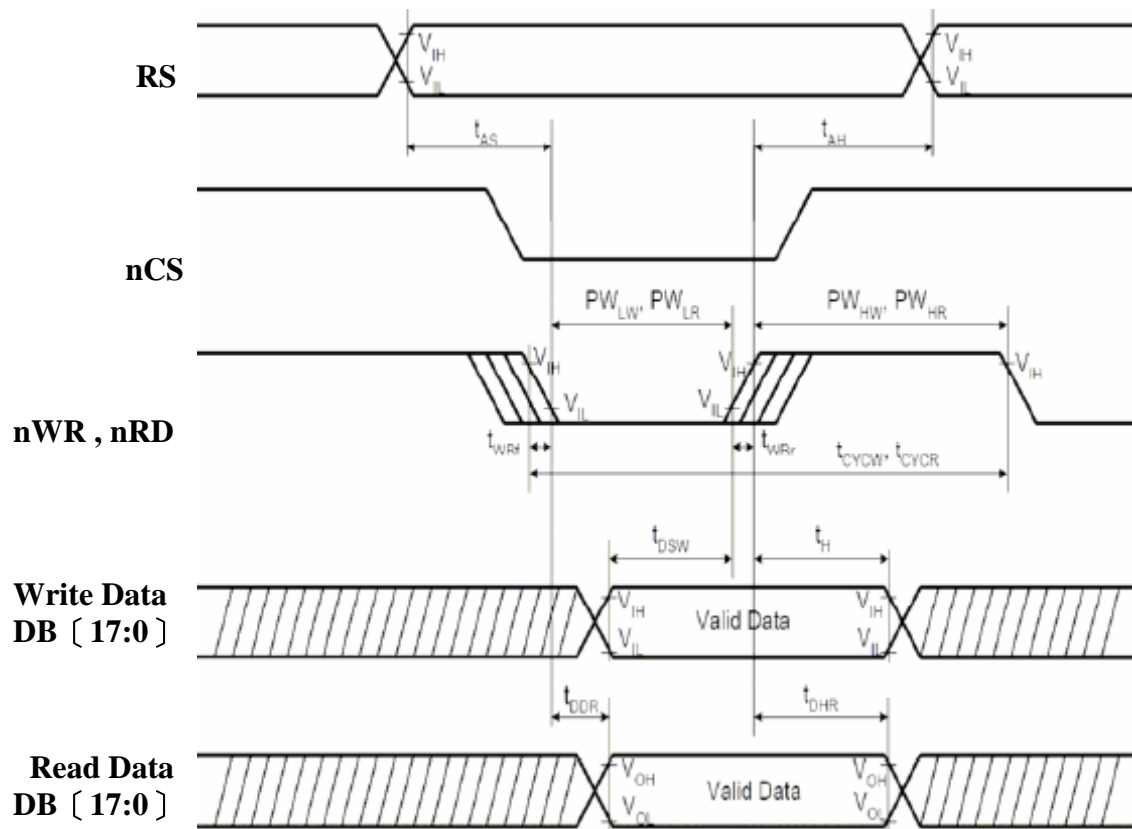

4.4.2 Reset Timing

| Item | Symbol | Units | Min | Typ | Max |
|-----------------------|-----------|-------|-----|-----|-----|
| Reset Low-Level Width | t_{RES} | ms | 1 | -- | -- |
| Reset Rise Time | t_{RES} | us | -- | -- | 10 |



| | | | | | |
|-----------------------|--------|------------------|----------|--------------|---------|
| Product Specification | Model: | MTF-TQ28NP911-LB | Rev. No. | Issued Date. | Page. |
| | | | A | Feb.27,09 | 10 / 26 |

4.4.3 Power ON/OFF

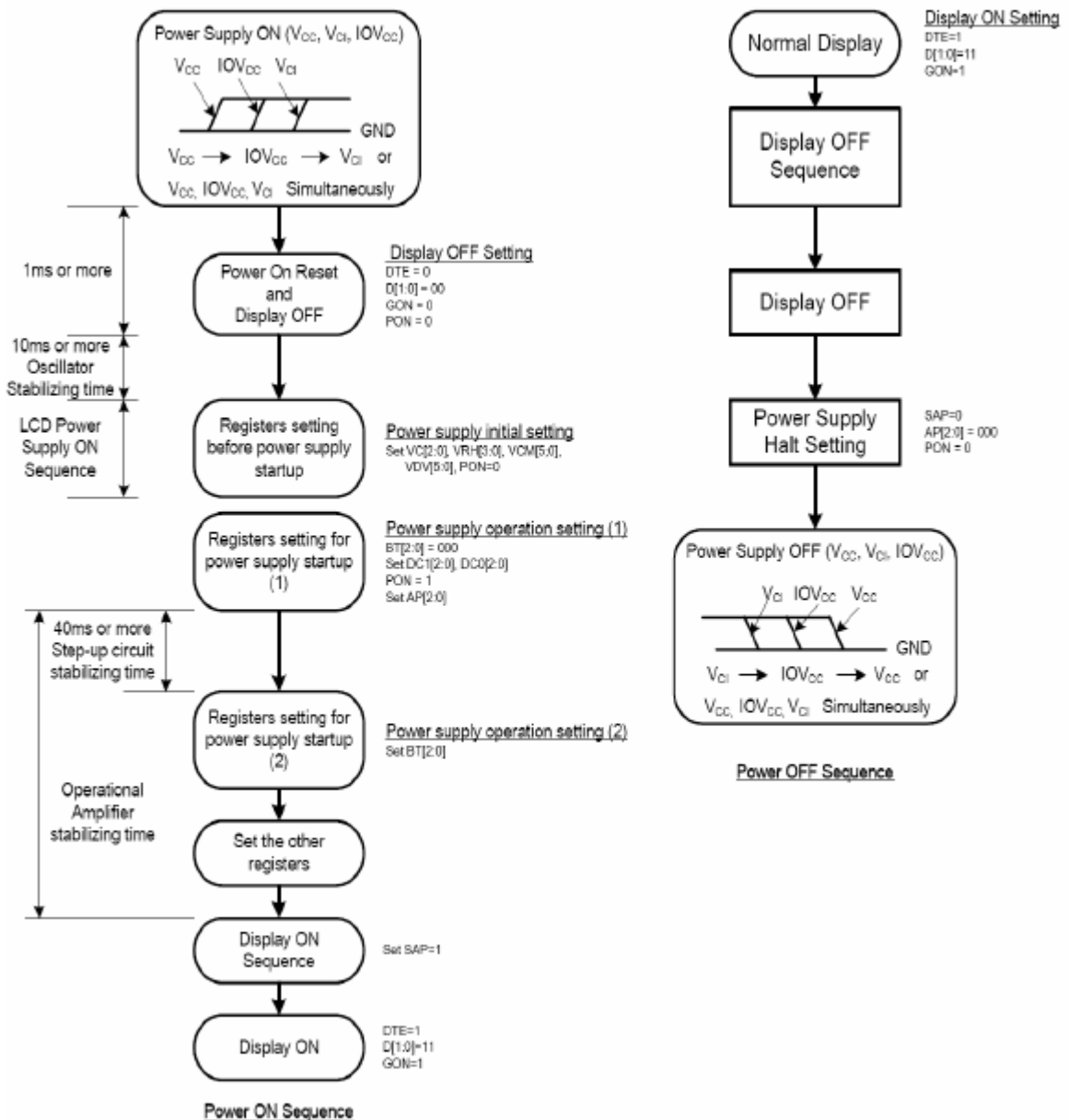

| | | | | | |
|-----------------------|--------|------------------|----------|--------------|---------|
| Messrs. | | | | | |
| Product Specification | Model: | MTF-TQ28NP911-LB | Rev. No. | Issued Date. | Page. |
| | | | A | Feb.27,09 | 11 / 26 |

4.4.4 Display ON/OFF

Display off Flow

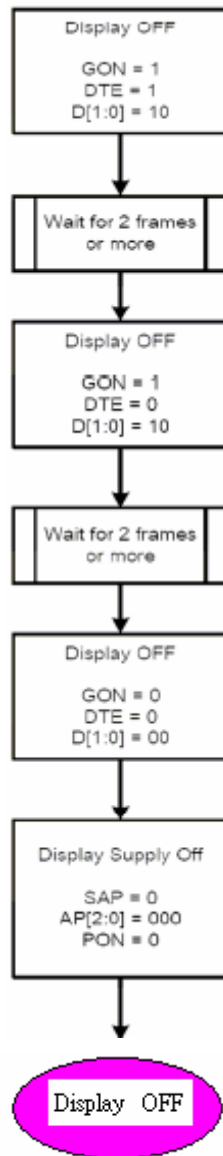

Display on Flow

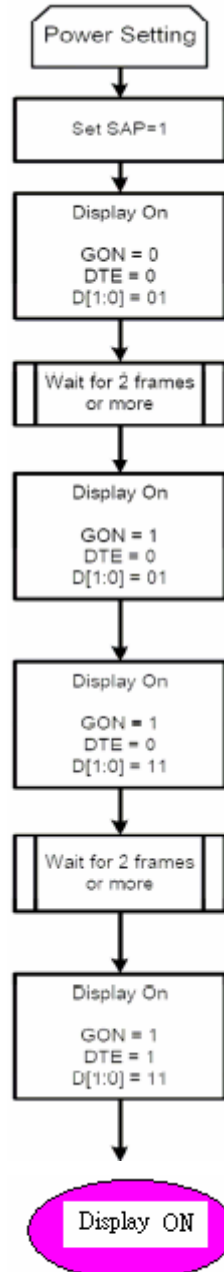

| | | | | | |
|-----------------------|--------|------------------|----------|--------------|---------|
| Messrs. | | | | | |
| Product Specification | Model: | MTF-TQ28NP911-LB | Rev. No. | Issued Date. | Page. |
| | | | A | Feb.27,09 | 12 / 26 |

4.5 GRAM Address Map & Read / Write

[! 80 18-/16-bit System Bus Interface Timing](#)

(a) Write to GRAM

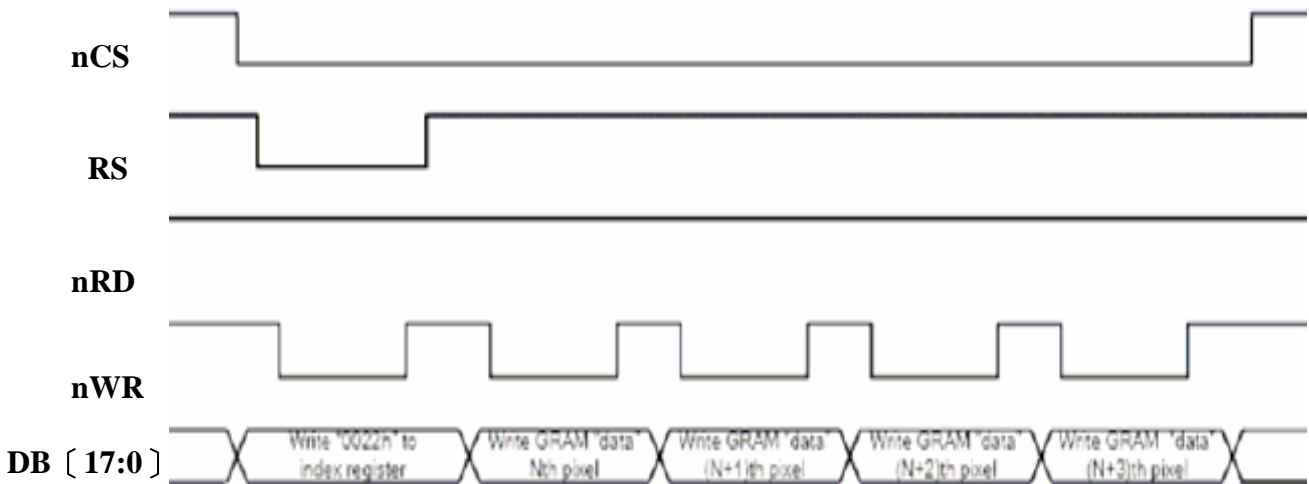

(b) Read form GRA

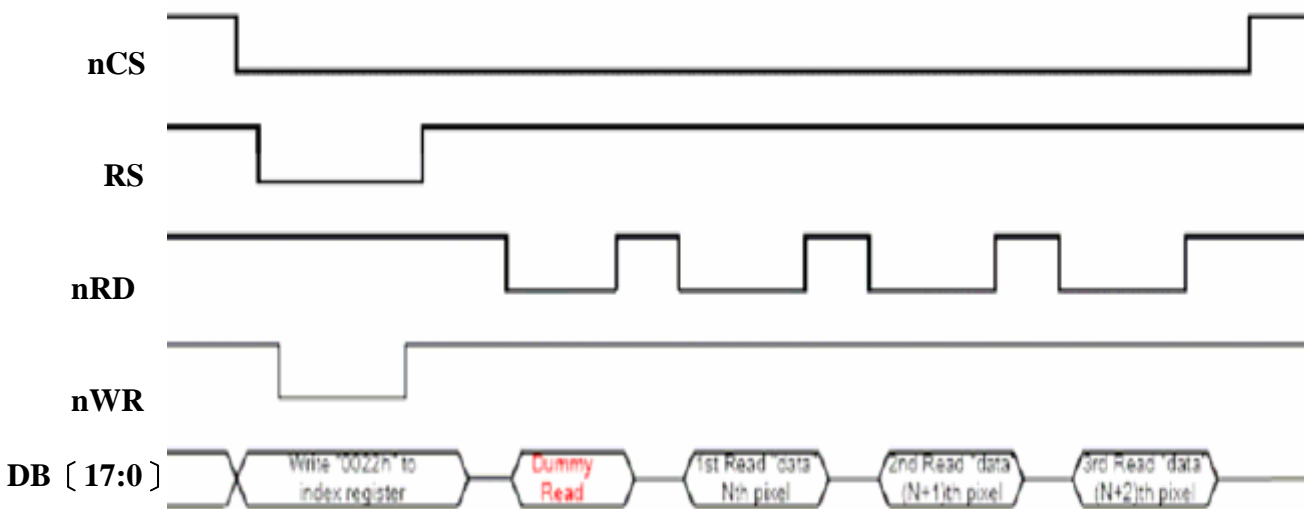

| | | | | | |
|-----------------------|--------|------------------|----------|--------------|---------|
| Messrs. | | | | | |
| Product Specification | Model: | MTF-TQ28NP911-LB | Rev. No. | Issued Date. | Page. |
| | | | A | Feb.27,09 | 13 / 26 |

! 80 9-/ 8-bit System Bus Interface Timing

(a) Write to GRAM

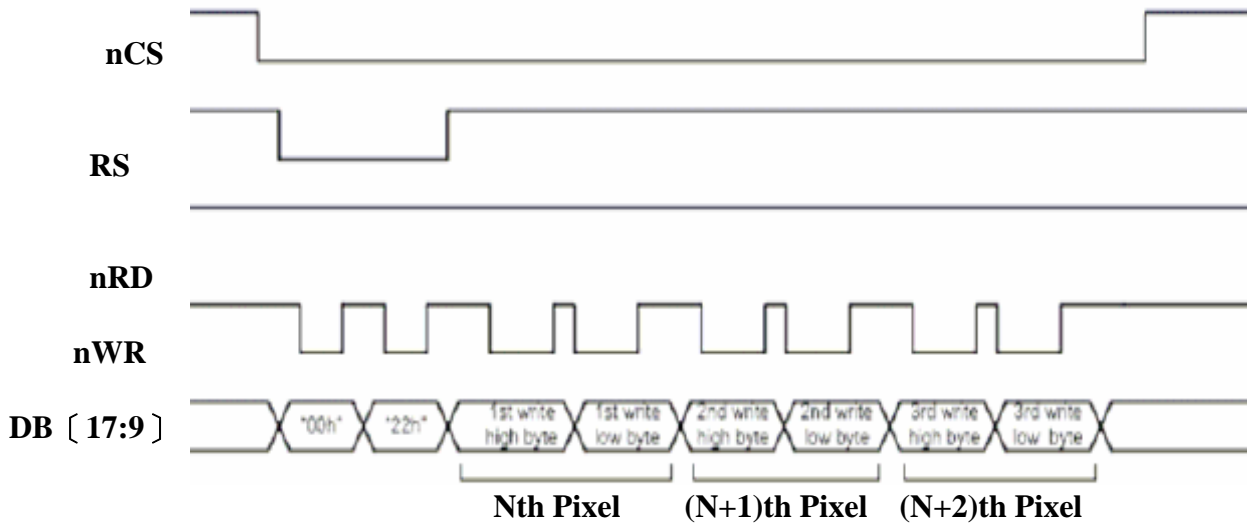

(b) Read form GRA

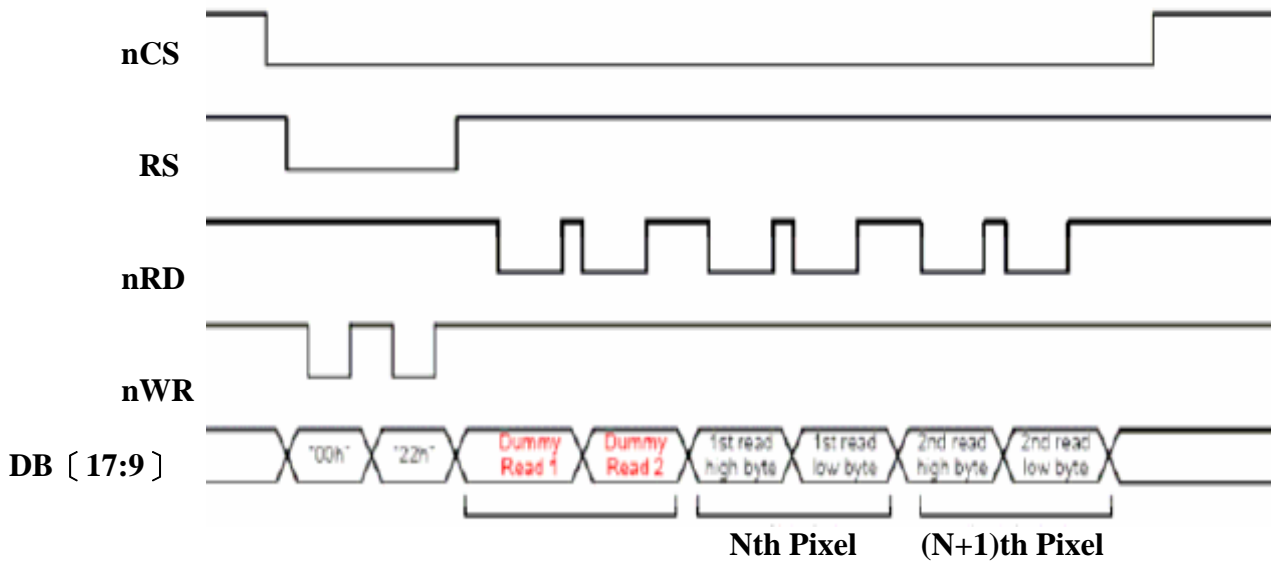

| | | | | | |
|-----------------------|--------|------------------|----------|--------------|---------|
| Messrs. | | | | | |
| Product Specification | Model: | MTF-TQ28NP911-LB | Rev. No. | Issued Date. | Page. |
| | | | A | Feb.27,09 | 14 / 26 |

5. ELECTRO-OPTICAL CHARACTERISTICS

| Parameter | | Symbol. | Min. | Typ. | Max. | Units. | Note. |
|------------------------------|---------------------------------------|------------|-------|-------|-------|-------------------|------------------|
| Luminance of white | | Lwh | 170 | -- | -- | cd/m ² | -- |
| Contrast Ratio | | CR | -- | 300 | -- | -- | * 5 |
| Response Time (Tr + Tf) | | -- | -- | 30 | -- | ms | * 4 |
| Viewing Angle (CR ≥ 10) | X axis right ($\phi = 0^\circ$) | θ_x | -- | 60 | -- | Degree | * 6 |
| | X axis left ($\phi = 180^\circ$) | θ_x | -- | 60 | -- | | |
| | Y axis up ($\phi = 90^\circ$) | θ_y | -- | 60 | -- | | |
| | Y axis down ($\phi = 270^\circ$) | θ_y | -- | 50 | -- | | |
| CIE color Coordinates | White | Wx | 0.290 | 0.310 | 0.330 | -- | BM7; 2° angle |
| | | Wy | 0.323 | 0.343 | 0.363 | | |
| | Red | Rx | 0.584 | 0.604 | 0.624 | | |
| | | Ry | 0.305 | 0.325 | 0.345 | | |
| | Green | Gx | 0.279 | 0.299 | 0.319 | | |
| | | Gy | 0.547 | 0.567 | 0.587 | | |
| Blue | Bx | 0.115 | 0.135 | 0.155 | | | |
| | By | 0.127 | 0.147 | 0.167 | | | |

● **For LCM**

Note1: Ambient temperature=25°C±2°C.

Note2: To be measured in the dark room.

Note3: To be measured at the center area of panel with a viewing cone of 2° by
Topcon luminance meter BM-7, after 10 minutes operation (module).



Microtips Technology Inc.

| | | | | | |
|-----------------------|--------|------------------|----------|--------------|---------|
| Messrs. | | | | | |
| Product Specification | Model: | MTF-TQ28NP911-LB | Rev. No. | Issued Date. | Page. |
| | | | A | Feb.27,09 | 15 / 26 |

Note4: Definition of response time:

The output signals of photo detector are measured when the input signals are changed from "black" to "white" (falling time) and from "white" to "black" (rising time), respectively. The response time is defined as the time interval between the 10% and 90% of amplitudes.

Refer to figure as below:

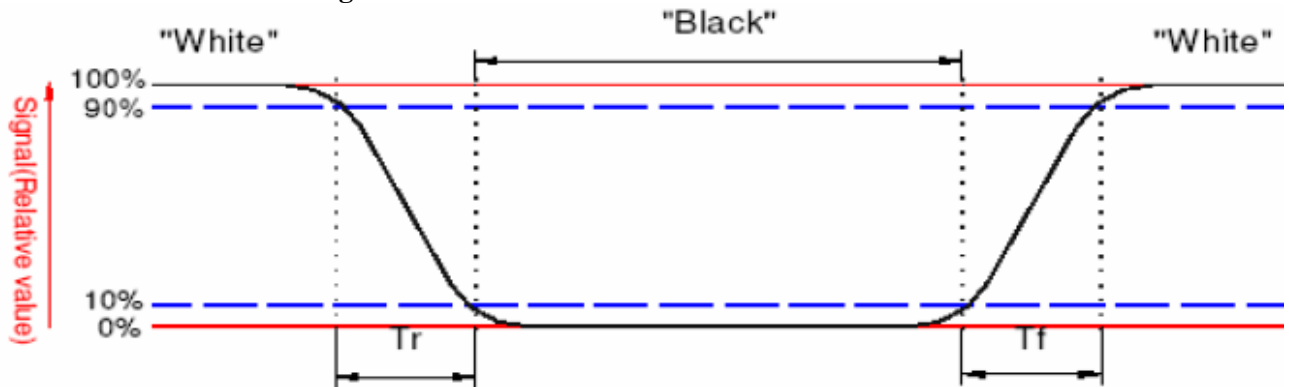

Note5: Definition of contrast ratio: **Contrast ratio is calculated with the following formula.**

$$\text{Contrast ratio (CR)} = \frac{\text{Photo detector output when LCD is at "White" state}}{\text{Photo detector output when LCD is at "Black" state}}$$

Note6: Definition of viewing angle (LCD-5200): **Refer to the figure as below**

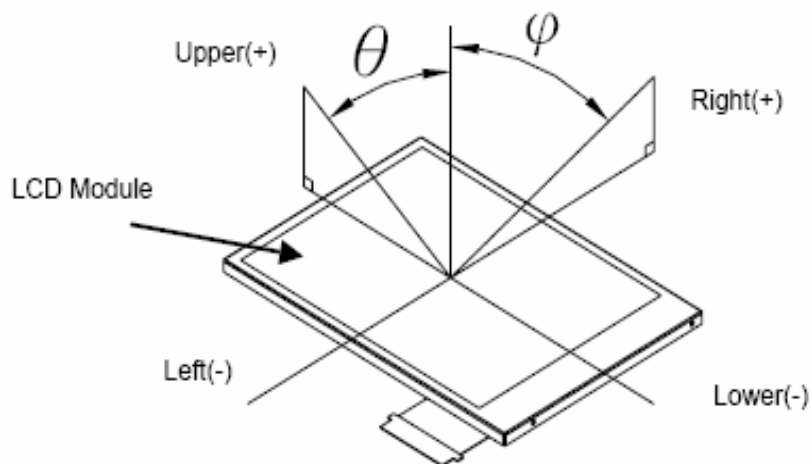

5.1 Reliability of Touch Panel



Microtips Technology Inc.

| | | | | | |
|-----------------------|--------|------------------|----------|--------------|---------|
| Messrs. | | | | | |
| Product Specification | Model: | MTF-TQ28NP911-LB | Rev. No. | Issued Date. | Page. |
| | | | A | Feb.27,09 | 16 / 26 |

| No | Items | Min. | Typ. | Max. | Unit | Remark |
|----|---------------------------|-----------|------|------|------------|---|
| 1 | Activation Force | 130 | -- | -- | g | 1. within active area. 2. R0.8mm polyacetal pen or finger. |
| 2 | Surface Hardness | 3 | -- | -- | H | Judgment ref. JIS-K5600 |
| 3 | Durability (Writing Life) | 100,000 | -- | -- | characters | 1. within active area. 2. R0.8mm polyacetal pen. 3. Load: 150g 4. Speed: 60mm/sec |
| 4 | Durability (Pitting Life) | 1,000,000 | -- | -- | touches | 1. within active area. 2. R0.8mm polyacetal pen. 3. Load: 250g 4. Frequency: 260 times/min |

6. RELIABILITY

6.1 MTTF

The LCD module shall be designed to meet a minimum MTTF value of 50,000 hours with normal condition.

(25°C in the room without sunlight; not include life time of backlight)

6.2 Tests

| NO | Item | Condition | Criterion |
|----|---|---|--|
| 1 | High Temperature Operating | 70°C 240hrs | * No defect of Operational function in Room temperature are Allowable. |
| 2 | Low Temperature Operating | -20°C 240hrs | |
| 3 | High Temperature Non-Operating | 80°C 240hrs | |
| 4 | Low Temperature Non-Operating | -30°C 240hrs | |
| 5 | High Temperature / Humidity Non-Operating | 50°C , 90%HR 240hrs | * Leakage current should Be below double of initial value. |
| 6 | Temperature Shock Non-Operating | -30°C ↔ 80°C (30min) (5min) (30min) 10 CYCLES | |
| | Electro-static Discharge | HBM : ±2Kv | |

Note1: Test after 24 hours in room temperature.

Note2: The sampling above is Individually for each reliability testing condition.

Note3: The color fading of polarizing filter should not care.

Note4: All of the reliability testing chamber above, is using D.I. water. (Min value: 1.0 MΩ-cm)

Note5: In case of malfunction defect caused by ESD damage, if it would be recovered to Normal state after resetting, it would be judged as a good part.



Microtips Technology Inc.

| | | | | | |
|-----------------------|--------|------------------|----------|--------------|---------|
| Messrs. | | | | | |
| Product Specification | Model: | MTF-TQ28NP911-LB | Rev. No. | Issued Date. | Page. |
| | | | A | Feb.27,09 | 17 / 26 |

7. INSPECTION CRITERIA

7.1 Inspection Conditions

Environmental conditions

The environmental conditions for inspection shall be as follows

Room temperature: $23 \pm 5^\circ\text{C}$

Humidity: $50 \pm 20\% \text{RH}$

The external visual inspection

With a single 1000 ± 200 lux fluorescent lamp as the light source, the inspection was in the distance of 30cm or more from the LCD to the inspector's eyes.

7.2 Light Method

Environment lamp under 1000 ± 200 lux, Viewing direction for inspection over 30cm The distance from eye to defect around 300mm, the distance from ND Filter to defect around 25~30mm

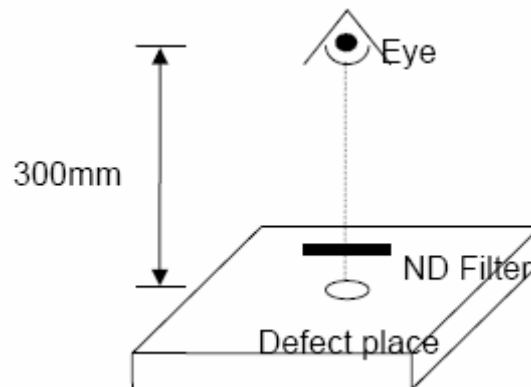

7.3 Classification of Defects

Minor defect

A major defect refers to a defect that may substantially degrade usability for product applications.

Minor defect

A minor defect refers to a defect which is not considered to be able substantially degrade the Product application or a defect that deviates from existing standards almost unrelated to the effective use of the product or its operation.

Notes: If the LCD/LCM 's cosmetic and display performance do not specify in "inspection criterion", it should be based on these delivered samples.



Microtips Technology Inc.

| | | | | | |
|-----------------------|--------|------------------|----------|--------------|---------|
| Messrs. | | | | | |
| Product Specification | Model: | MTF-TQ28NP911-LB | Rev. No. | Issued Date. | Page. |
| | | | A | Feb.27,09 | 18 / 26 |

7.4 Sampling & Acceptable Quality Level

Level II, MIL-STD-105E

| -- | Major | Minor |
|--------------------|-------|--------|
| Cosmetic | 1.0 % | 1.5 % |
| Electrical-display | 0.4% | 0.65 % |

7.5 Definition Of Inspection Area

V.A: Viewing Area

A.A: Active Area

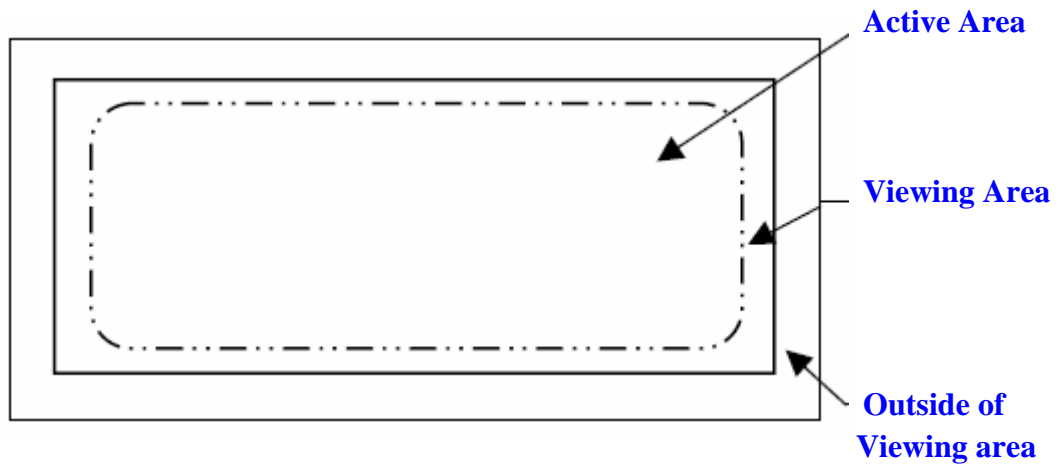

| | | | | | |
|-----------------------|--------|------------------|----------|--------------|---------|
| Messrs. | | | | | |
| Product Specification | Model: | MTF-TQ28NP911-LB | Rev. No. | Issued Date. | Page. |
| | | | A | Feb.27,09 | 19 / 26 |

7.6 Items and Criteria
Visual inspection criterion in cosmetic

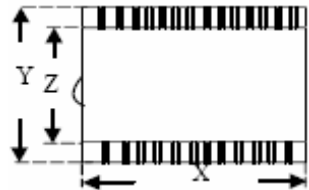
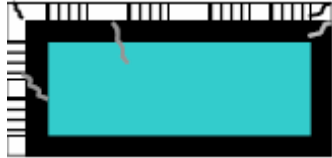
| Glass defect | | | |
|--------------|----------------------|-----------------------------|---|
| No | Defect | Criteria | Remark |
| 1 | Dimension (Minor) | By engineering diagram |  |
| 2 | Cracks (Major) | Extensive crack 【Reject】 |  |

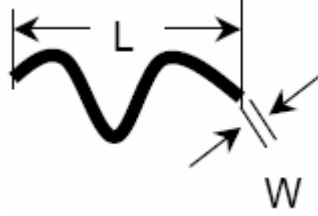
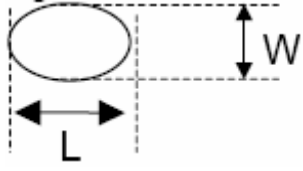
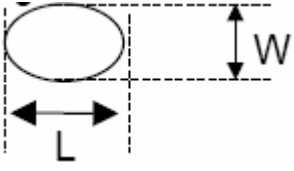
| LCD appearance defect with in V.A | | | | |
|-----------------------------------|---------------------------------------|---|-----------------|--|
| No | Defect | Criteria | | Remark |
| 1 | Fiber, scratches (Major) | Spec. | Permissible Qty | 1. L: Length, W: Width 2. Disregard if out off A.A.  |
| | | $W \leq 0.03\text{mm}$ | Disregard | |
| | | $0.03\text{mm} < W \leq 0.05\text{mm}$, $L \leq 3.0\text{mm}$ | 2 | |
| | | $0.05\text{mm} < W \leq 0.10\text{mm}$, $L \leq 3.0\text{mm}$ | 1 | |
| | | $W > 0.10\text{mm}$ or $L > 3.0\text{mm}$ | 0 | |
| 2 | Dirty Spots, Round type (Major) | Spec. | Permissible Qty | 1. $\phi = (L+W)/2$, L: Length, W: Width 2. Disregard if out of A.A.  |
| | | $\phi \leq 0.10\text{mm}$ | Disregard | |
| | | $0.10\text{mm} < \phi \leq 0.20\text{mm}$ | 3 | |
| | | $0.20\text{mm} < \phi$ | 0 | |
| 3 | Polarizer dent (Major) | Spec. | Permissible Qty | 1. $\phi = (L+W)/2$, L: Length, W: Width 2. Disregard if out of A.A.  |
| | | $\phi \leq 0.20\text{mm}$ | Disregard | |
| | | $0.20\text{mm} < \phi \leq 0.30\text{mm}$ | 2 | |
| | | $0.30\text{mm} < \phi \leq 0.50\text{mm}$ | 1 | |
| | | $0.50\text{mm} < \phi$ | 0 | |

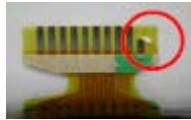

| | | | | | |
|-----------------------|--------|------------------|----------|--------------|---------|
| Messrs. | | | | | |
| Product Specification | Model: | MTF-TQ28NP911-LB | Rev. No. | Issued Date. | Page. |
| | | | A | Feb.27,09 | 20 / 26 |

| FPC | | | |
|-----|---------------------------|-----------------------------------|---|
| No | Item | Criteria | Remark |
| 1 | Copper Peeling (Minor) | Copper Peeling 【Reject】 |  |

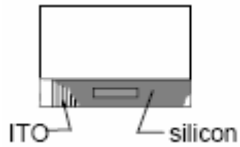
| Silicon | | | |
|---------|------------------------------|--------------------------------|---|
| No | Item | Criteria | Remark |
| 1 | Amount of silicon (Minor) | ITO exposed 【Reject】 |  |

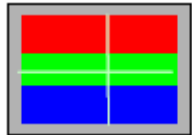
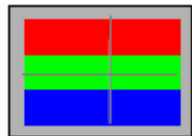
| LCD appearance defect | | | | |
|-----------------------|-----------------------------------|-------------------|-----------------|---|
| No | Defect | Criteria | | Remark |
| 1 | No display (Major) | Not allowable | |  |
| 2 | Missing line (Major) | Not allowable | |  |
| 3 | Darker or lighter line (Major) | By limited sample | |  |
| 4 | Dot defect (Major) | Spec. | Permissible Qty | 1. dot =1R or 1G or 1B 2. Dot defect area \geq 1/2 dot 3. Disregard if out of AA area |
| | | Bright dot | 1 | |
| | | Dark dot | 2 | |
| 5 | Mura (Minor) | By limited sample | | -- |

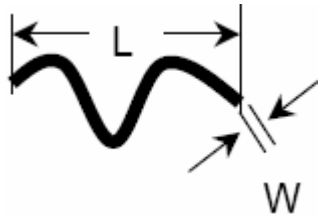
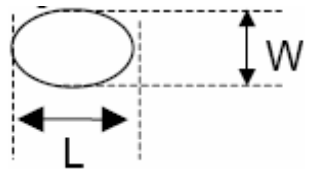

| | | | | | |
|-----------------------|--------|------------------|----------|--------------|---------|
| Messrs. | | | | | |
| Product Specification | Model: | MTF-TQ28NP911-LB | Rev. No. | Issued Date. | Page. |
| | | | A | Feb.27,09 | 21 / 26 |

| LCD appearance defect | | | | |
|-----------------------|-----------------------------|---|-----------------|--|
| No | Defect | Criteria | | Remark |
| 6 | Fiber, scratches (Major) | Spec. | Permissible Qty | 1. L: Length, W: Width 2. Disregard if out off A.A.  |
| | | $W \leq 0.03\text{mm}$ | Disregard | |
| | | $0.03\text{mm} < W \leq 0.05\text{mm}$, $L \leq 3.0\text{mm}$ | 2 | |
| | | $0.05\text{mm} < W \leq 0.10\text{mm}$, $L \leq 3.0\text{mm}$ | 1 | |
| | | $W > 0.10\text{mm}$ or $L > 3.0\text{mm}$ | 0 | |
| 7 | Dirty spots (Major) | Spec. | Permissible Qty | 1. $\phi = (L+W)/2$, L: Length, W: Width 2. Disregard if out of A.A.  |
| | | $\phi \leq 0.10\text{mm}$ | Disregard | |
| | | $0.10\text{mm} < \phi \leq 0.20\text{mm}$ | 3 | |
| | | $0.20\text{mm} < \phi$ | 0 | |

Others

1. Issues that are not defined in this document shall be discussed and agreed with both parties.
(Customer and supplier)
2. Unless otherwise agreed upon in writing, the criteria shall be applied to both parties.
(Customer and supplier)



Microtips Technology Inc.

| | | | | | |
|-----------------------|--------|------------------|----------|--------------|---------|
| Messrs. | | | | | |
| Product Specification | Model: | MTF-TQ28NP911-LB | Rev. No. | Issued Date. | Page. |
| | | | A | Feb.27,09 | 22 / 26 |

8. PRECAUTIONS





8.1 Operation

Burn-in sometimes happens when the same character was displayed at along time. Therefore, to prevent Burn-in, it is recommended to set up a Screen-saver function.

8.2 Safety





The liquid crystal in the LCD is poisonous, DO NOT put it in your mouth. If the liquid crystal touches your skin or clothes, wash it off immediately using soap and water.

8.3 Handling

| | |
|---|--|
|  | <p>a. The LCD module shall be installed flat, without twisting or bending.</p> <p>b. COF or FPC has narrow pattern width, so easily become open circuit by external force. DO NOT apply pressure to COF or FPC especially in bending area.</p> |
|  | <p>c. To avoid damage in appearance or malfunction, DO NOT subject the module to mechanical shock or to excessive force on its surface.</p> |
|  | <p>d. The polarizer attached to the display is very easy to be damaged, handle it with care to avoid scratching.</p> |
|  | <p>e. To avoid contamination on the display surface, DO NOT touch the display surface with bare hands.</p> <p>f. Provide a space so that the LCD module does not come into contact with other components.</p> |

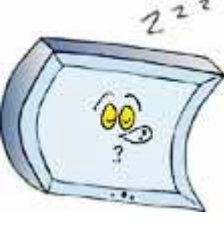
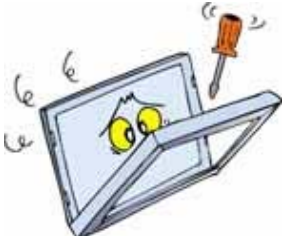

| | | | | | |
|-----------------------|--------|------------------|----------|--------------|---------|
| Messrs. | | | | | |
| Product Specification | Model: | MTF-TQ28NP911-LB | Rev. No. | Issued Date. | Page. |
| | | | A | Feb.27,09 | 23 / 26 |

| | |
|---|---|
|  | <p>g. To protect the LCD panel from external pressure, put covering glass (acrylic board or similar board) to keep appropriate space between them.</p> |
|  | <p>h. Be careful for condensation at sudden temperature change. Condensation makes damage to polarizer or electrical contacted parts. And after fading condensation, smear or spot will occur.</p> |
|  | <p>i. Property of semiconductor devices may be affected when they are exposed to light possibly resulting in malfunctioning of the ICs. To prevent such malfunctioning of the ICs, your design and mounting layout done are so that the IC is not exposed to light in actual use.</p> |
|  | <p>j. Strong light exposure causes degradation of color filter. It may not recover</p> |
|  | <p>k. DO NOT contact with water to avoid Metal corrosion.</p> <p>l. When it is not in use, the screen must be turned off or the pattern must be frequently changed by a screen saver. If it displays the same pattern for a long period of time, brightness down/image sticking may develop due to the LCD structure.</p> |
|  | <p>m. Never disassemble LCD product under any circumstances. If unqualified operators or users assemble the product after disassembling it, it may not function or its operation may be seriously affected.</p> |



| | | | | | |
|-----------------------|--------|------------------|----------|--------------|---------|
| Messrs. | | | | | |
| Product Specification | Model: | MTF-TQ28NP911-LB | Rev. No. | Issued Date. | Page. |
| | | | A | Feb.27,09 | 24 / 26 |

8.4 Static electricity

Since a module is composed of electronic circuits, it is not strong to electrostatic discharge.

| | |
|---|--|
|  | <ol style="list-style-type: none"> The LCD module shall be installed flat, without twisting or bending. Ground soldering iron tips, tools and testers when they operate. Ground your body when handling the products. DO NOT apply voltage to the input terminal without applying power supply. DO NOT apply voltage that exceeds the absolute maximum rating. Store the products in an anti-electrostatic container. Peel off protect tape, attached to polarizer, slowly to minimize ESD damage. |
|---|--|

8.5 Storage

| | |
|---|--|
|  | <p>Store the products in a dark place at +5 ~ +25 degree C, low humidity (50%RH or less). DO NOT store the products in an atmosphere containing organic solvents or corrosive gases.</p> |
|---|--|

8.6 Cleaning

| | |
|---|--|
|  | <ol style="list-style-type: none"> DO NOT wipe the polarizer with dry cloth, as it might cause scratch. Wipe the polarizer with a soft cloth soaked with petroleum IPA, other chemical might damage. |
|---|--|

8.7 Waste

| | |
|---|--|
|  | <p>When dispose of LCD module, manage it at the production waste according to the relevant laws and regulations.</p> |
|---|--|



| | | | | | |
|-----------------------|--------|------------------|----------|--------------|---------|
| Messrs. | | | | | |
| Product Specification | Model: | MTF-TQ28NP911-LB | Rev. No. | Issued Date. | Page. |
| | | | A | Feb.27,09 | 25 / 26 |

9. WARRANTY

This product has been manufactured to your company's specifications as a part for use in your company's general electronic products. It is guaranteed to perform according to delivery specifications. For any other use apart from general electronic equipment, we cannot take responsibility if the product is used in medical devices, nuclear power control equipment, aerospace equipment, fire and security systems, or any other applications in which there is a direct risk to human life and where extremely high levels of reliability are required. If the product is to be used in any of the above applications, we will need to enter into a separate product liability agreement.

- 1 13 months guarantee starts from the date code.
- 2 We cannot accept responsibility for any defect, which may arise from additional manufacturing of the product (including disassembly and reassembly), after product delivery.
- 3 We cannot accept responsibility for any defect, which may arise after the application of strong external force to the product.
- 4 We cannot accept responsibility for any defect, which may arise due to the application of static electricity after the product has passed your company's acceptance inspection procedures.
- 5 We cannot accept responsibility for industrial property, which may arise through the use of your product, with exception to those issues relating directly to the structure or method of manufacturing of our product. Microtips-origin longer than one year from Microtips production.

10. DIMENSIONAL OUTLINES

See next page.....



Microtips Technology Inc.

